

RoHS Compliant 

REV	ECN No.	DATE	REMARK
A0	NEW	2016.07.10	新版发行
A1	ECN1612001	2016.12.23	变更新料号
A2	ECN1805012	2018.05.29	镀金1u => 3u
A3	ECN1901002	2019.01.14	增加公差
A4	ECN1908008	2019.08.24	变更新图号, 更换新图框

NOTE:

- MATERIAL SPECIFICATION:
 - HOUSING: HIGH TEMPERATURE RESISTANT PLASTIC(LCP), UL94 V-0.
 - CONTACTS: COPPER ALLOY(C1814) T=0.12mm
 - MID PLATE: STAINLESS STEEL(SUS301) T=0.20mm
 - EMI PLATE: STAINLESS STEEL(SUS301) T=0.10mm
 - SHELL: STAINLESS STEEL(SUS304) T=0.30mm
- PLATING SPECIFICATION:
 - CONTACTS:
 - Ni 50u" MIN. UNDER PLATED OVER ALL.
 - Au PLATED ON THE FUNCTIONAL AREA OF CONTACT. (GOLD PLATING THICKNESS FOLLOW THE P/N)
 - PLATING SPECIFICATIONS OF THE SOLDER AREA FOLLOW THE P/N
 - FRONT SHELL&OUTER SHELL:
 - Ni 30u" MIN. UNDER PLATED OVER ALL.
 - MID PLATE:
 - Ni 30u" MIN. UNDER PLATED OVER ALL.
 - Sn 80u" MIN. PLATED OVER ALL
 - EMI PLATE:
 - CLEAR ONLY
- MECHANICAL PERFORMANCE,
 - INSERTION FORCE: 0.5~2.0kgf.
 - EXTRACTION FORCE: 0.8kgf~2.0kgf.
 - DURABILITY: 10000 CYCLES.
- ELECTRICAL PERFORMANCE,
 - CURRENT RATING: 5.0A
VOLTAGE RATING: 5.0V
 - LLCR:
 - VBUS & GND PINS AND OTHER PINS: 40mΩ/PIN MAX.
 - SHIELD: 50mΩ/MAX.
 - LLCR MAX. CHANGE OF ALL PINS: 10mΩ.
 - INSULATION RESISTANCE: 100MΩ MIN
 - DIELECTRIC WITHSTAND VOLTAGE, AC 100V FOR 1 MINUTE.
- ENVIRONMENTAL PERFORMANCE:
 - OPERATING TEMPERATURE: -25°C~+85°C.
- IR REFLOW:
 - THE PEAK TEMPERATURE ON THE BOARD SHALL BE MAINTAINED FOR 10 SECONDS AT 260°C.

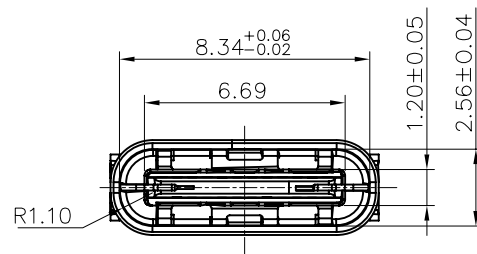
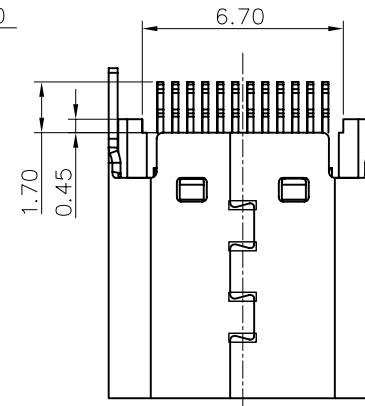
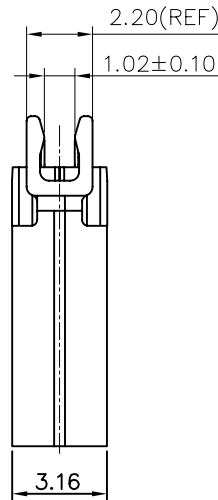
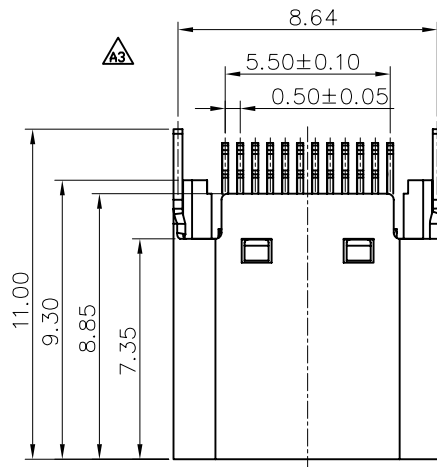
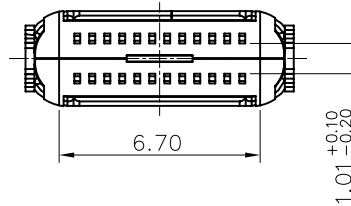
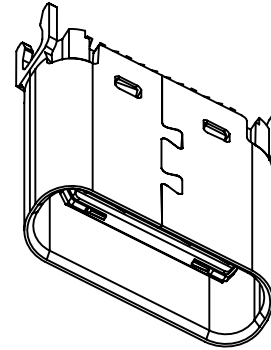

TABLE:

PART NUMBER	NO.	DESCRIPTION	MATERIAL	REMARKS	QTY	PACKAGING
Z-CF012SLB02T-A-01	5	SHELL	STAINLESS STEEL	Ni Plated	1PCS	TRAY
	4	SPRING	STAINLESS STEEL	---	2PCS	
	3	SHIELDING PLATE	STAINLESS STEEL	Ni Plated	1PCS	
	2	CONTACT	COPPER ALLOY	COPPER ALLOY T=0.12MM, G/F PLATING ON CONTACT AREA; TIN PLATING ON SOLDER TAIL, UNDERPLATING OVERALL	1SET	
	1	HOUSING	HIGH TEMPERATURE PLASTIC	BLACK	1PCS	

PART NO.: SEE THE PART NUMBER CODE		Goldconn Technologies Co., Ltd		DRAWN BY SAM	DATE 2019.08.24
GENERAL TOLERANCES (UNLESS SPECIFIED)		TITLE USB C F TYPE 夹板式 1.0 短体 9.3		CHECKED BY JAY	DATE 2019.08.24
QUALITY SYMBOL	0	DWG.NO. CF012-01	SHEET NO. 1 OF 3	APPROVED BY JACKY	DATE 2019.08.24
0	0	DIMENSION STYLE MM ONLY	DESIGN UNITS METRIC	SCALE 1:1	
0	0	THIRD ANGLE PROJECTION			

frame size: A4

RoHS Compliant 

REV	ECN No.	DATE	REMARK
A0	NEW	2016.07.10	新版发行
A1	ECN1612001	2016.12.23	变更新料号
A2	ECN1805012	2018.05.29	镀金1u => 3u
A3	ECN1901002	2019.01.14	增加公差
A4	ECN1908008	2019.08.24	变更新图号, 更换新图框

50PCS PRODUCTS PER TUBE

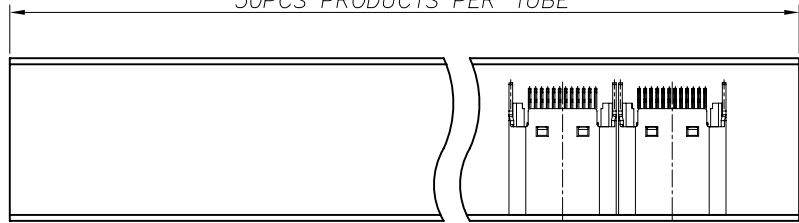
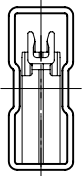

TUBE

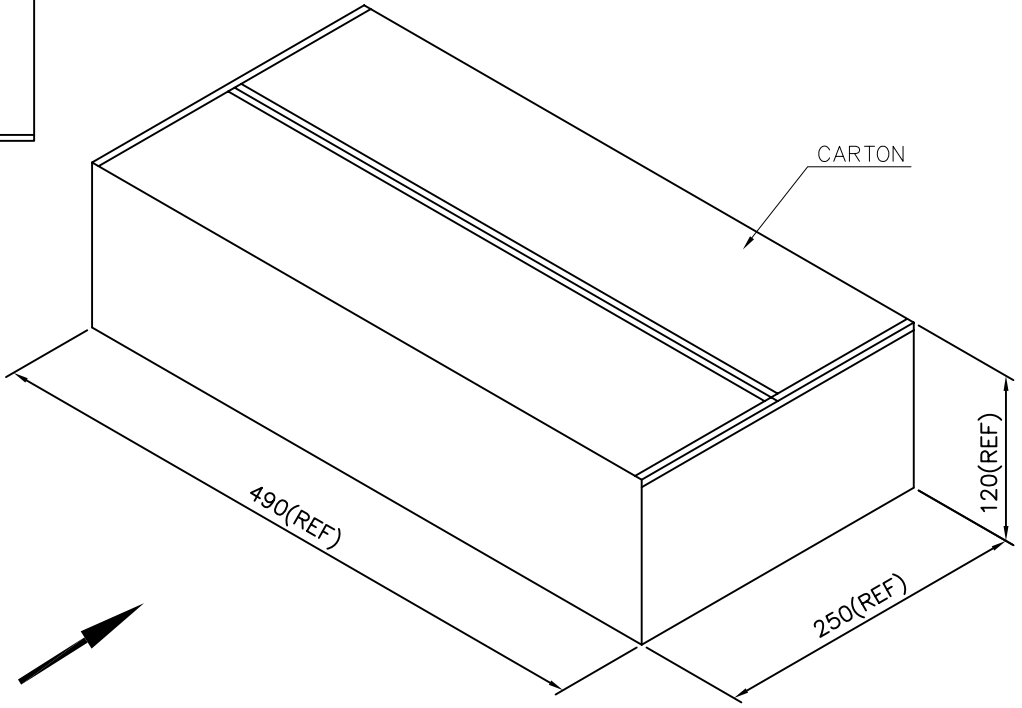
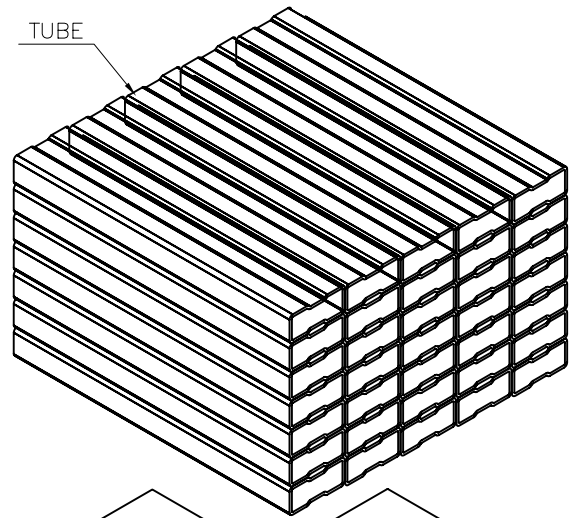

CARTON

490(REF)

250(REF)

120(REF)

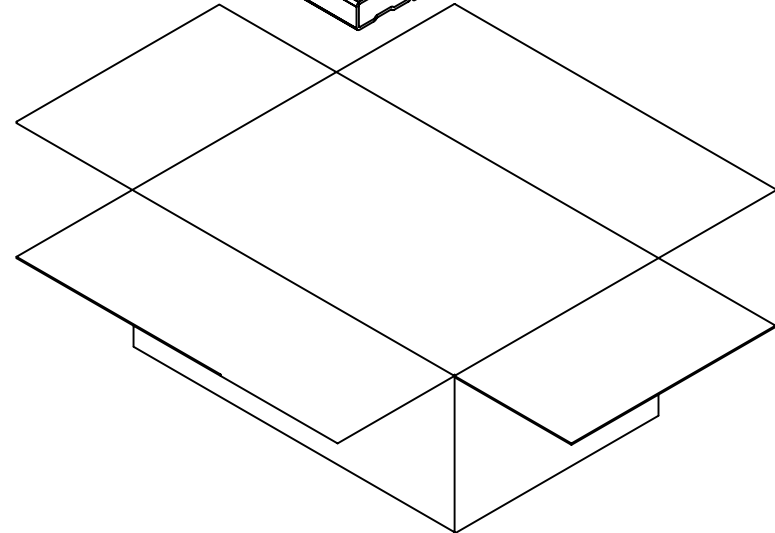

	TUBE	CARTON
CONNECTOR (PCS)	50	18000

PART NO.: SEE THE PART NUMBER CODE		Goldconn Technologies Co., Ltd		DRAWN BY SAM	DATE 2019.08.24
GENERAL TOLERANCES (UNLESS SPECIFIED)		TITLE USB C F TYPE 夹板式1.0 短体9.3		CHECKED BY JAY	DATE 2019.08.24
QUALITY SYMBOL	0	DWG.NO. CF012-01	SHEET NO. 3 OF 3	APPROVED BY JACKY	DATE 2019.08.24
0	0	DIMENSION STYLE MM ONLY	SCALE 1:1	THIRD ANGLE PROJECTION	
0	0	DESIGN UNITS METRIC	frame size: A4		
ANGULAR	---				